

FLUKE®

1735

Power Logger

Users Manual

March 2006 Rev. 2, 3/10

© 2006-2010 Fluke Corporation, All rights reserved. Specifications are subject to change without notice. All product names are trademarks of their respective companies.

LIMITED WARRANTY AND LIMITATION OF LIABILITY

Each Fluke product is warranted to be free from defects in material and workmanship under normal use and service. The warranty period is two years and begins on the date of shipment. Parts, product repairs, and services are warranted for 90 days. This warranty extends only to the original buyer or end-user customer of a Fluke authorized reseller, and does not apply to fuses, disposable batteries, or to any product which, in Fluke's opinion, has been misused, altered, neglected, contaminated, or damaged by accident or abnormal conditions of operation or handling. Fluke warrants that software will operate substantially in accordance with its functional specifications for 90 days and that it has been properly recorded on non-defective media. Fluke does not warrant that software will be error free or operate without interruption.

Fluke authorized resellers shall extend this warranty on new and unused products to end-user customers only but have no authority to extend a greater or different warranty on behalf of Fluke. Warranty support is available only if product is purchased through a Fluke authorized sales outlet or Buyer has paid the applicable international price. Fluke reserves the right to invoice Buyer for importation costs of repair/replacement parts when product purchased in one country is submitted for repair in another country.

Fluke's warranty obligation is limited, at Fluke's option, to refund of the purchase price, free of charge repair, or replacement of a defective product which is returned to a Fluke authorized service center within the warranty period.

To obtain warranty service, contact your nearest Fluke authorized service center to obtain return authorization information, then send the product to that service center, with a description of the difficulty, postage and insurance prepaid (FOB Destination). Fluke assumes no risk for damage in transit. Following warranty repair, the product will be returned to Buyer, transportation prepaid (FOB Destination). If Fluke determines that failure was caused by neglect, misuse, contamination, alteration, accident, or abnormal condition of operation or handling, including overvoltage failures caused by use outside the product's specified rating, or normal wear and tear of mechanical components, Fluke will provide an estimate of repair costs and obtain authorization before commencing the work. Following repair, the product will be returned to the Buyer transportation prepaid and the Buyer will be billed for the repair and return transportation charges (FOB Shipping Point).

THIS WARRANTY IS BUYER'S SOLE AND EXCLUSIVE REMEDY AND IS IN LIEU OF ALL OTHER WARRANTIES, EXPRESS OR IMPLIED, INCLUDING BUT NOT LIMITED TO ANY IMPLIED WARRANTY OF MERCHANTABILITY OR FITNESS FOR A PARTICULAR PURPOSE. FLUKE SHALL NOT BE LIABLE FOR ANY SPECIAL, INDIRECT, INCIDENTAL OR CONSEQUENTIAL DAMAGES OR LOSSES, INCLUDING LOSS OF DATA, ARISING FROM ANY CAUSE OR THEORY.

Since some countries or states do not allow limitation of the term of an implied warranty, or exclusion or limitation of incidental or consequential damages, the limitations and exclusions of this warranty may not apply to every buyer. If any provision of this Warranty is held invalid or unenforceable by a court or other decision-maker of competent jurisdiction, such holding will not affect the validity or enforceability of any other provision.

Fluke Corporation
P.O. Box 9090
Everett, WA 98206-9090
U.S.A.

Fluke Europe B.V.
P.O. Box 1186
5602 BD Eindhoven
The Netherlands

Table of Contents

Title	Page
Introduction	1
Contacting Fluke.....	1
Symbols	2
Safety Instructions	3
Standard and Optional Accessories.....	5
Software and Information CD-ROM	7
Instrument Familiarity	7
Current Probes	7
Control Elements, Display	7
Display Symbols	8
Description of the Control Elements.....	9
Using the SAVE and CURSOR Keys.....	10
Connectors.....	11
USB Interface	11
Installing the USB Driver	11
Basic Adjustments (Menu).....	12
Menu Structuring	12
Short Overview of the Menu.....	13
Charging the Internal Battery.....	14
Basic Operation	14
Parameter Configuration.....	15
Logging Menu.....	15
View/Delete Screenshots	17
View Auto Screenshots.....	18
Instrument Setup.....	19
Current Probes	19
Voltage Transformers	21
Phase Identification.....	21
Backlight.....	21
Display Contrast	21
Version & Calibration.....	21
Power Network	22
Date & Time	22
Language	22
Measuring Functions.....	23

Overview	23
Meter Volts / Amps / Hz	23
Scope	23
Harmonics	23
Power	23
Events	24
Connecting the Power Logger to the Network	24
Color Coding Wire Clips	25
Single and Split Phase Connections	26
Split Phase	28
Measurement in a Three-Phase Power Network	29
Volts / Amps / Hertz	32
Logging	33
Measurement	33
Save	34
Logging Function	34
Power	35
Measurement	36
Three-Phase Power Theory	37
Save	38
Logging Function	39
Logging	40
Events	40
Save	41
Logged Events	41
Harmonics	42
Measurement	42
Logger Function	43
Logging	44
Save	44
Scope	45
Measurement	45
Save	46
Power Log PC Software	46
Installing Power Log Software	46
Starting Power Log	46
Using Power Log	47
Energy Recording with Fluke Power Log	49
Recording Power (Demand) with 1735 Power Logger	51
Inside the Logger	52
Line Power or Battery Mode	52
Replacing the Battery Pack	52
Maintenance	54
Cleaning	54
Calibration	54
Storage	54
Measurement Theory	55
Waveform	55

Power Measurements	55
Total Harmonic Distortion	57
Specifications	57
General	57
Temperature Ranges	57
EMC	58
Safety	58
V-RMS Wye Measurement	58
V-RMS Delta Measurement	59
A-RMS Measurement	59
Power Measurement (P, S, D)	60
PF (Power Factor)	60
Frequency Measurement	60
Harmonics	61
Events	61
Unbalance	62
Recorded Values	63

List of Tables

Table	Title	Page
1.	Symbols	2
2.	Standard Equipment.....	5
3.	Optional Accessories	6
4.	Maximum Possible Measuring Periods.....	51

List of Figures

Figure	Title	Page
1.	Display Symbols.....	8
2.	Control Elements.....	9
3.	Power Logger Connectors.....	11
4.	Menu Overview.....	13
5.	Using the Optional Mini Clamps.....	25
6.	Single Phase Connections.....	27
7.	Split Phase Connections.....	29
8.	Three-Phase Wye Connections.....	30
9.	Three-Phase Delta Δ Connections-Blondel (Aron, Two-Element Delta).....	31
10.	Three-Phase Delta Δ Connections-Blondel (Aron, Three-Element Delta).....	32
11.	Fluke Power Log Screen.....	47
12.	Fluke Power Log Displaying Three Phases of Voltage and Current.....	48
13.	Replacing the Battery Pack.....	53

1735 Power Logger

Introduction

With this 1735 Power Logger (referred to throughout this manual as “Logger”) you can conduct voltage, current and power studies for determining existing loads. The Logger is also a general-purpose power quality investigative tool that reveals the quality of voltage supply at any point in a distribution network.

The Logger was developed in particular for plant electricians and electrical installers, who have an important role in investigating and solving disturbances of the power distribution system.

Your 1735 Power Logger is equipped with Flash Technology. This enables you to perform firmware updates. Please use the Windows Flash Update utility to do this. You will find it on the supplied 1735 CD-ROM. If there is a firmware update, it can be found on the Fluke website: www.fluke.com.

Contacting Fluke

To contact Fluke, call one of the following telephone numbers:

- Technical Support USA: 1-800-44-FLUKE (1-800-443-5853)
- Calibration/Repair USA: 1-888-99-FLUKE (1-888-993-5853)
- Canada: 1-800-36-FLUKE (1-800-363-5853)
- Europe: +31 402-675-200
- Japan: +81-3-3434-0181
- Singapore: +65-738-5655
- Anywhere in the world: +1-425-446-5500

Or, visit Fluke's website at www.fluke.com.

To register your product, visit <http://register.fluke.com>.

To view, print, or download the latest manual supplement, visit <http://us.fluke.com/usen/support/manuals>.

Address correspondence to:











Fluke Corporation
P.O. Box 9090,
Everett, WA 98206-9090
U.S.A.

Fluke Europe B.V.
P.O. Box 1186,
5602 BD Eindhoven
The Netherlands

Symbols

Table 1 lists the symbols used on the instrument and/or in this manual.

Table 1. Symbols

Symbol	Description
	Important information. See manual.
	Hazardous voltage.
	Earth ground.
	Double insulation.
	DC (Direct Current).
	Conforms to requirements of European Union.
	Canadian Standards Association is the certified body used for testing compliance to safety standards.
	Do not dispose of this product as unsorted municipal waste. Go to Fluke's website for recycling information.
	Conforms to relevant Australian Standards.
	Do not apply around or remove from HAZARDOUS LIVE conductors.
CAT III	IEC Overvoltage Category III CAT III equipment is designed to protect against transients in installations, such as distribution panels, feeders and short branch circuits, and lighting systems in large buildings.

Safety Instructions

Please read this section carefully. It will make you familiar with the most important safety instructions for handling your Logger. In this manual, a **Warning** identifies conditions and actions that pose hazard(s) to the user. A **Caution** identifies conditions and actions that may damage the Calibrator or the test instruments.

⚠️⚠️ Warnings

To prevent possible electrical shock or personal injury, follow these guidelines:

- **The Logger must only be used and handled by qualified personnel.**
- **Adhere to local and national safety codes. Individual protective equipment must be used to prevent shock injury where hazardous live conductors are exposed.**
- **To avoid electrical shock, remove all test leads from the Logger before you open the battery door. Open the Logger only to replace the rechargeable battery.**
- **Maintenance work must be done only by qualified service personnel.**
- **Use only specified current probes. If you use flexible current probes, wear suitable protective gloves or work on de-energized conductors.**
- **Protect the Logger against dampness, wetness and humidity.**
- **To prevent electrical shock, always connect voltage and current test leads to the Logger before connecting to the load.**

- **The plug and socket connection for the voltage lead set is designed for 600 V CAT III. The maximum voltage between outer conductor and earth potential must not exceed 600 V. With multi-phase connections, phase-phase voltage may not exceed 800 V.**
- **Use only the provided original or specified accessories. This includes the ac power adapter.**

Adequate qualifications are the following:

- Trained and authorized to switch on/off, ground (earth) and mark power distribution circuits and devices in accordance with the safety standards of electrical engineering.
- Training or instruction in accordance with the standards of the safety engineering in maintenance and use of appropriate safety equipment.
- Training in first aid.

Standard and Optional Accessories

The standard equipment for the Power Logger is listed in Table 2. Optional accessories are listed in Table 3.

Table 2. Standard Equipment

Equipment	Model or Part Number
Power Logger	Fluke-1735
Battery Charger, BC1735, 115V/230V 50/60 Hz	2584895
International AC Power Plug Set For Battery Charger	2441372
FS17XX, Shielded 4-Phase Flexi Set for Models 1735, 1743, 1744, 1745 (15A/150A/1500A)	2637462
VL1735/45,BANANA 4-PHASE VOLTAGE LEAD SET FOR FLUKE-1735/45	3276205
Dolphin Clip, Black	2540726
WC17XX, COLOR CODE WIRE CLIPS	2637481
Rechargeable Battery,NiMH 7.2V	2625171
Soft Case	1642656
CD-ROM,FLUKE-1735 MANUAL AND SOFTWARE Includes: manuals, PC application software, firmware upgrade utility (English, French, German, Italian, Spanish, Portuguese, Simplified Chinese, Czech, Polish, Russian, Turkish, Swedish)	2583487
1735 Getting Started Manual	3611908
USB 2.0 Connection Cable, Mini USB B5 Male – USB A Male	3671726

Table 3. Optional Accessories

Description	Model or Part Number
11A/10A CLAMP PQ4, 4-PHASE 1A/10A MINI CURRENT CLAMP SET FOR PQ	3024424
15A/50A CLAMP PQ3, 3-PHASE 5A/50A MINI CURRENT CLAMP SET FOR PQ	3024436
15A/50A CLAMP PQ4, 4-PHASE 5A/50A MINI CURRENT CLAMP SET FOR PQ	3024449
120/200A CLAMP PQ3, 3-PHASE 20A/200A MINI CURRENT CLAMP SET FOR PQ	3024451
120/200A CLAMP PQ4, 4-PHASE 20A/200A MINI CURRENT CLAMP SET FOR PQ	3024460
3000/6000A FLEX 4,3000A/6000A 36-INCH FLEXI PROBE 4 PHASE	3024472
11A/10A CLAMP PQ3, 3-PHASE 1A/10A MINI CURRENT CLAMP SET FOR PQ	3024413
1-PHASE 1A/10A MINI CURRENT CLAMP SET FOR PQ	3345753
1-PHASE 5A/50A MINI CURRENT CLAMP SET FOR PQ	3345766
SHIELDED 1-PHASE FLEXI SET FOR MODELS 1735, 1743, 1744, 1745	3345748
FS17XX IP65, IP65 RATED 4-PHASE FLEXI SET FOR MODELS 1735, 1743, 1744, 1745	3474696
3000/6000A FLEX 4,3000A/6000A 36-INCH FLEXI PROBE 4 PHASE	3024472

Inspect the contents of the shipping box for completeness and damage. If there is any damage, report the damage to your shipper.

Software and Information CD-ROM

The CD-ROM delivered with the Logger contains additional, important information. This includes:

- International manuals
- Power Log PC application software
- 1735 Upgrade Utility for future Logger upgrades
- USB Drivers

Instrument Familiarity

Note

Please charge the battery before the first operation or use the provided charging adapter at the beginning.

Current Probes

Fluke flexi-sets or current clamps are automatically detected by the Logger when the Logger is turned on. If you change current probes, turn the Logger off and on again so the Logger can recognize the new probe.

Control Elements, Display

This section familiarizes you with the display and the controls.

Turn the Logger on by turning the rotary switch in clockwise direction. The display shows the selected measuring function.

Display Symbols

Figure 1 shows the display symbols the Power Logger uses.

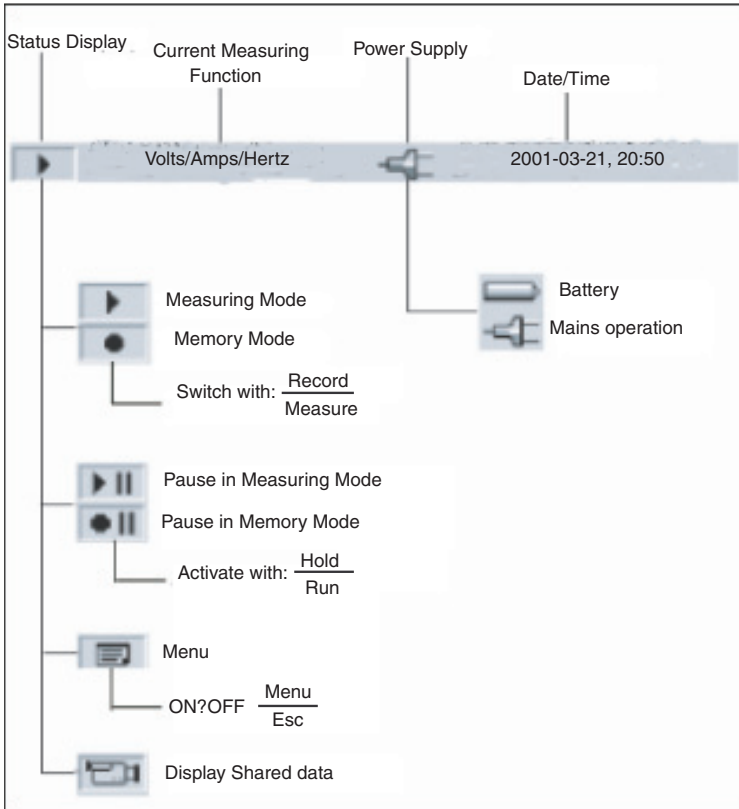

Figure 1. Display Symbols

edx004.eps

Description of the Control Elements

Figure 2 indicates the control elements of the Power Logger.

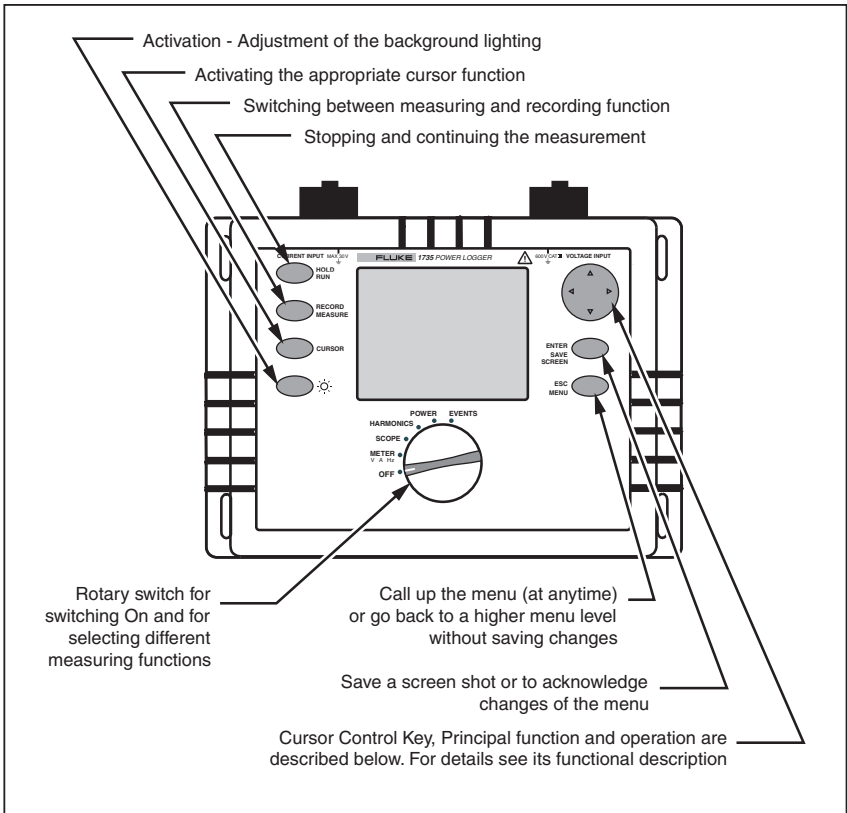

Figure 2. Control Elements

Note

The symbols occurring in this operating instruction \triangle ∇ and \triangleleft \triangleright correspond to the respective directions of the cursor control keys.

Using the SAVE and CURSOR Keys

Pressing the ENTER/SAVE SCREEN key saves the current picture as a screenshot.

Since it is a screenshot, a saved picture cannot be modified or edited with the cursor.

The cursor control keys (◀ ▶ △ ▽) are activated once you are in HOLD mode. The CURSOR key activates HOLD mode and displays a cursor (vertical line) for detailed analysis of measurement results.

Pressing the CURSOR key starts cursor mode. Press ◀ and ▶ to move the cursor and read the current values on the display.

Pressing the CURSOR key in the view logged data mode sets a reference cursor.

Screenshots can also be taken in cursor mode.

Pressing ESC exits cursor mode and returns to the hold mode. From HOLD mode, different parameters may be selected and Cursor mode may be re-entered by pressing CURSOR.

Connectors

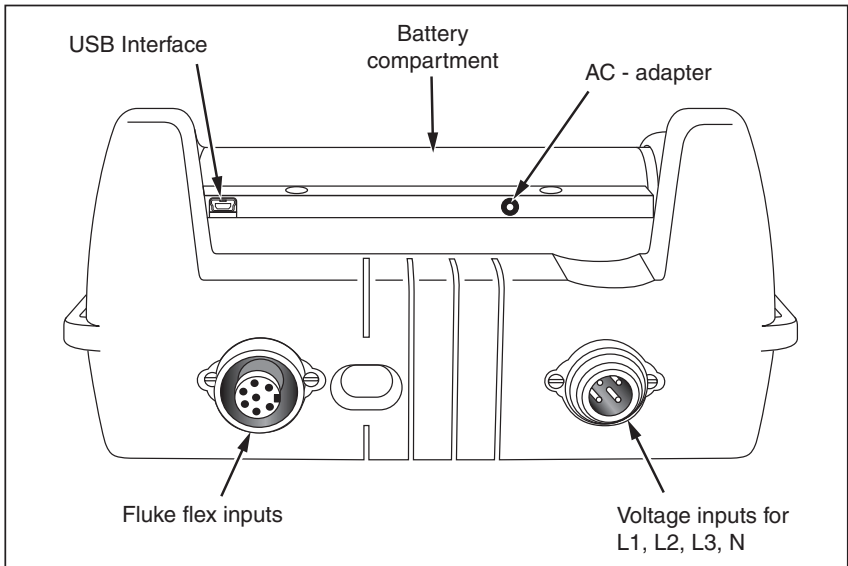

edx006.eps

Figure 3. Power Logger Connectors

USB Interface

The USB interface is used for communication with an external PC. Use Power Log software (included) to download and analyze logged data. This interface is also used for updating firmware using the 1735 Upgrade Utility. Refer to “Installing the USB Driver”.

Installing the USB Driver

USB drivers are located on the CD-ROM that came with the instrument. Note that some drivers will automatically load twice. See instrument manuals for more details.

To load the USB driver:

1. Run the *1735 Product CD-ROM* on a PC.
2. Click on **USB Driver Installation**.

3. Either select the default directory by clicking on **Install**, or click **Change Install Location...** and change the file path to a different location.
4. Follow the on screen instructions.
5. The necessary files are copied to the PC.
6. Restart the PC to conclude driver installation.

Basic Adjustments (Menu)

Menu Structuring

You make all basic adjustments of the Logger in the main menu. You can call this at any time with the key . If you push it again you return to the previous display.

Short Overview of the Menu

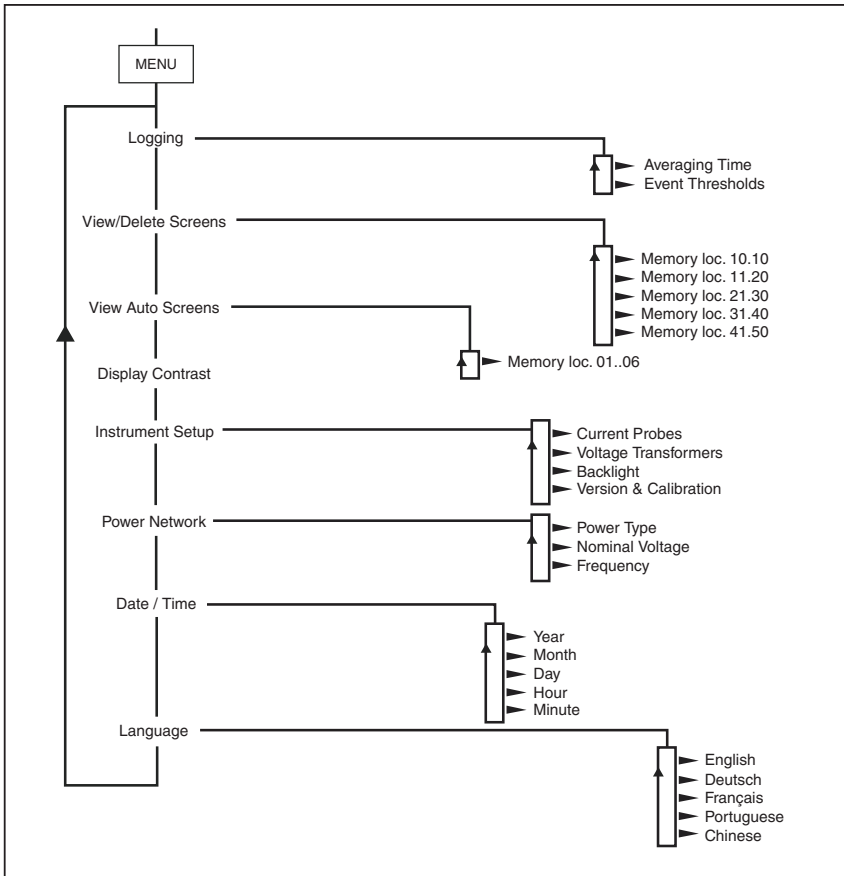

edx007.eps

Figure 4. Menu Overview

Charging the Internal Battery

Before you use the Logger, charge the internal battery as follows:

1. Switch the 1735 Battery Charger to either 115V or 230V as appropriate.
2. With the Logger power off, attach the BC1735 Battery Charger to a power outlet and then to the Logger.
3. Charge the Logger for 5 hours before using it for the first time.
4. On subsequent use, turn the Logger power on before you connect the BC1735 Battery Charger.

This helps ensure that the fast charge mode is activated. If the Logger does not turn on due to a discharged battery, recharge the battery for 5 hours with the Logger power off as described in steps 2 and 3 above.

Basic Operation

The following examples show how to select parameters in the menu.

- Entering the main menu: 
- Selecting menu options with the cursor control keys: \triangle ∇

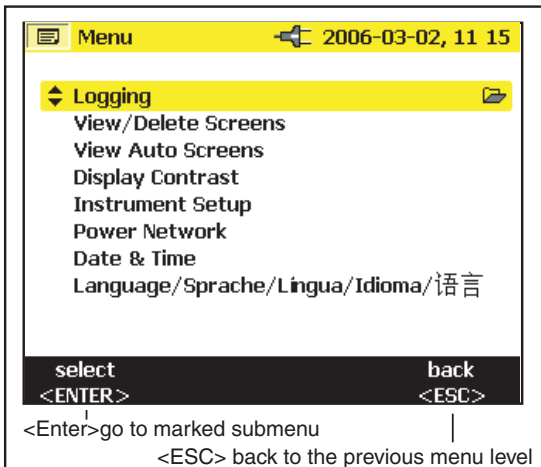

edx008.eps

Changing parameters:

- The displayed parameters can be modified with the cursor control keys (in the available preset values).
- If values are not preset you can modify them by using the cursor control keys. With ◀▶ you can select the decimal place and with △ ▽ you can modify the number.

Note

Selected parameters are stored in the memory with Enter. With ESC the adjusted value can be rejected at any time.

Parameter Configuration

Logging Menu

If you call the logging menu, then you can select between two further submenus: Menu for adjusting the averaging time and for adjusting the event threshold in recording adjustments.

In the menu *Averaging* you select the time over which the data are to be averaged. You can also select these values from the predefined values for averaging time. As you change the averaging time, you will see on the display the resulting logging time available for each averaging interval.

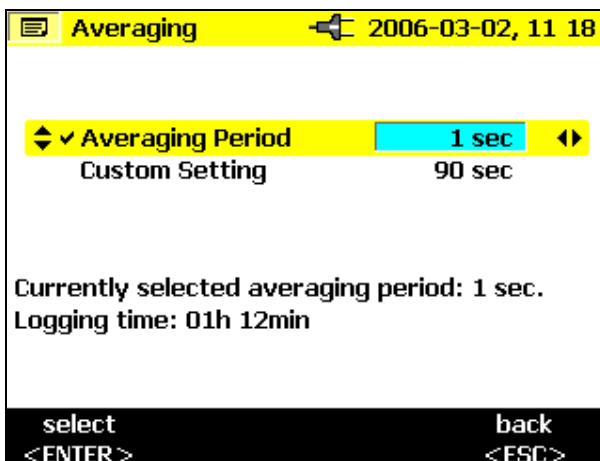

edx009.bmp

With *Custom Setting* you can choose any averaging time value. Depending on the selected averaging time, maximum available recording time is indicated in the display at the same time. Up to 4,320 averaging intervals can be recorded with the record function.

By selecting the menu *Event Thresholds* you can select the threshold voltage at which the recording is to be started (see also “Harmonics”).

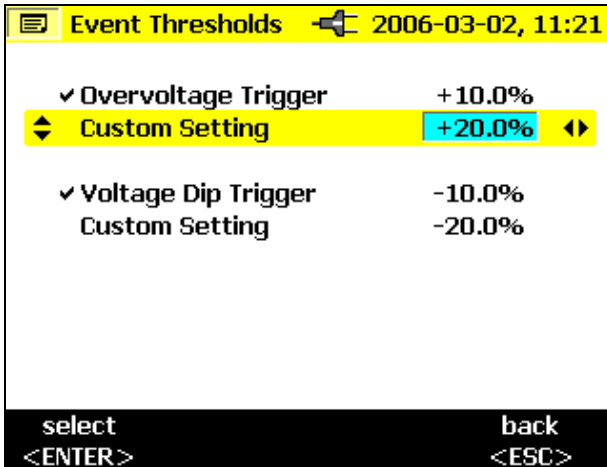

edx010.bmp

View/Delete Screenshots

Select one of the saved screenshots. Press *ENTER* to view it. All screenshots include the date and time and the measuring mode, in which they were saved. Each page lists 10 screens.

Use the ◀▶ to change the page.

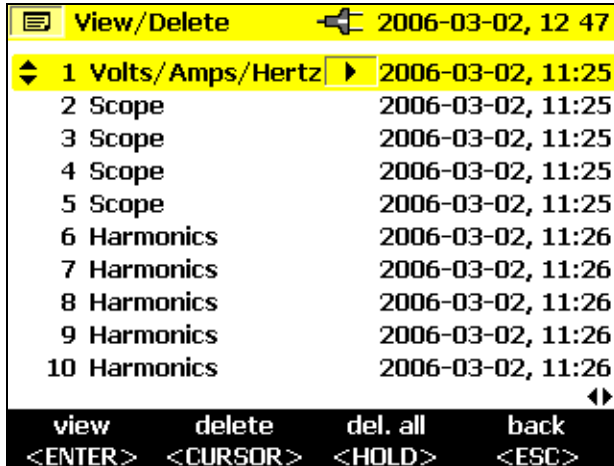

edx011.bmp

View Auto Screenshots

With this menu item, you can view the screenshots of a recording session, which have been automatically saved in the Save mode. 6 screenshots are available (01 to 06).

Select one of the pictures with the CURSOR key and press *ENTER* to view it.

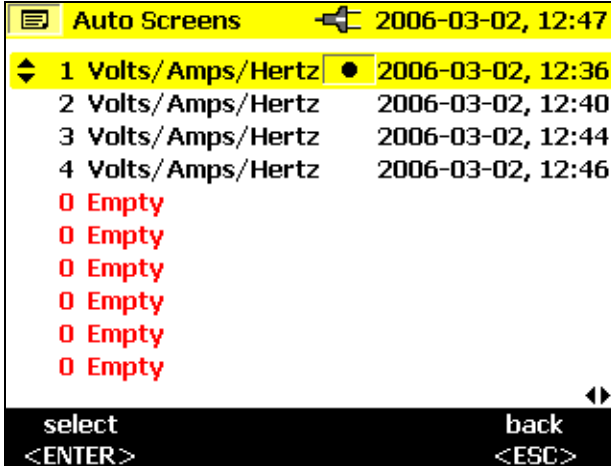

edx012.bmp

Note

Saved Auto Screenshots always show the currently displayed parameters.

Example: If you selected phase L2 in the Volt/Ampere/Hertz function and the recording reaches the margin of the picture, a screenshot of the current picture, i.e., phase L2, is saved.

Instrument Setup

In this menu option you can make adjustments in the submenu for:

- Current Probes
- Voltage Transformers
- Phase Identification
- Backlight
- Version and Calibration

These are described individually in the following:

Current Probes

When a Flexi set or Current Probe is connected to the instrument it is automatically recognized, but only at power-up. Select the current measuring range by pressing \leftrightarrow . If the secondary of a current transformer is being measured, it is possible to display the current in terms of the primary by entering a CT ratio into the current probe setting. The Transformer ratio setting is only available if one of the MINI clamps is attached. It is not available with Flexi sets.

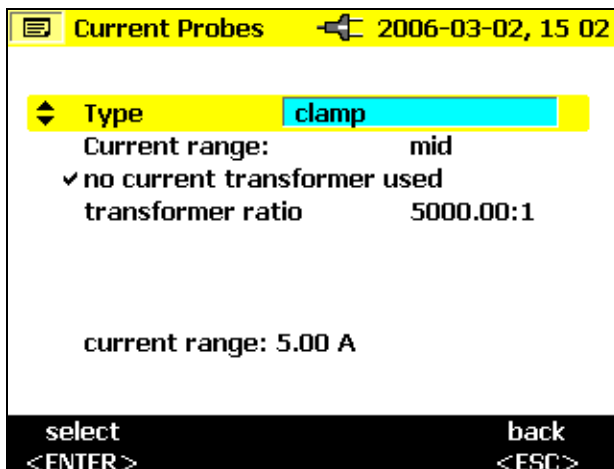

edx013.bmp

Use \triangle / ∇ to select *transformer ratio*

Use \triangleleft / \triangleright to enter the ratio

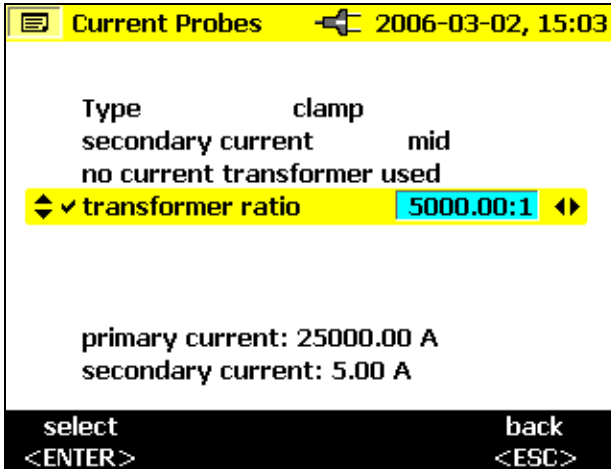

edx014.bmp

Use \triangleleft / \triangleright to select digit and \triangle / ∇ to adjust the value

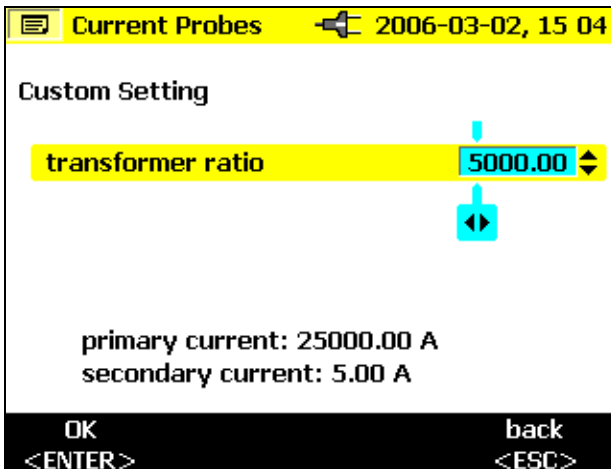

edx015.bmp

The effect of the ratio is shown at the foot of the display with the primary of the interposing transformer displayed above the secondary current (input to probe).

Press *ENTER* to confirm changes.

Voltage Transformers

If you use voltage transformers, select transformation ratio with *ENTER*. Press the ◀▶ key and enter any transformation ratio with △▽.

For transformation ratio details see information on the *voltage transformer*.

Phase Identification

Here you can choose whether the display shows “A, B, C” for phase identification or “L1, L2, and L3.” In this manual, phases are called A, B, and C, but this is equivalent to L1, L2, and L3.

Backlight

This selects whether the backlight deactivates automatically after 30 seconds or whether you want to always deactivate it manually after you turn it on with the ✱ key.

Note

If the battery is in use, use the backlight only if necessary in order to conserve battery life.

Display Contrast

Select the display contrast optimal for you with △▽.

Version & Calibration

This menu serves for your information. No adjustments can be made. The displayed data give information of type and version of the logger firmware.

Power Network

Select the Power Type (Single phase, split phase, wye, 2-element delta, 3-element delta), here. This is also where you select the nominal phase voltage and frequency.

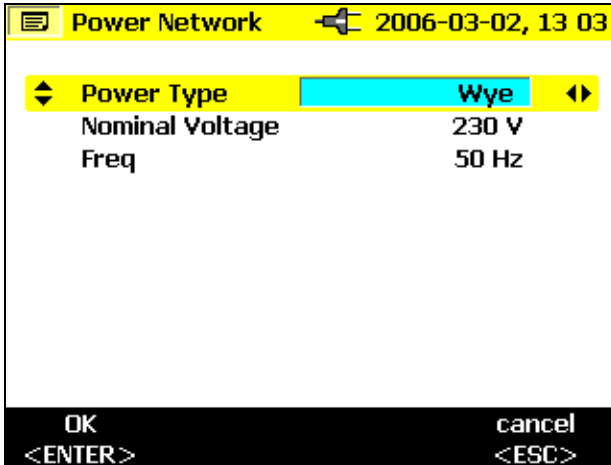

edx016.bmp

Date & Time

Here you can enter the current date and the current time.

Language

Presents a menu of the provided languages for the Logger displays.

Measuring Functions

Overview

The following information provides an overview of each rotary switch position.

Meter Volts / Amps / Hz

This function displays the voltage and current values at the same time, plus the frequency and the neutral-conductor current. You can also use this measuring function to get an overview of these values before you analyze the signal in detail in the other functions.

Scope

Scope shows the voltages, currents and the φ (phase) angle in oscilloscope representation as well as their instantaneous values at the cursor position. With this function you get a clear picture of current and voltage waveforms and their distortions.

Harmonics

Harmonics are sinusoidal voltages with a frequency that corresponds to an integer multiple of the fundamental (line) frequency.

Every repetitive signal can be split into an infinite number of sine waves of different frequency and amplitude. The contribution of each of these individual sine waves is represented in a bar chart up to the 40th harmonic. The smaller the harmonics are (starting from the 2nd harmonic, the 1st is the fundamental) the better is the power network quality.

Power

This function indicates the values of the transferred power. At the same time you can measure active power, reactive power, apparent power, distortion power and the appropriate power factor. You can also view the active and reactive power energy.

Note

Demand can be logged by setting the averaging period in the Setup menu to either 10 or 15 minutes, which produces a record of consecutive averages. This is called block demand.

Events

Events are voltage dips, swells and interruptions. This measuring mode automatically records all events for later evaluation. The threshold values for starting the recording are freely configurable in the menu.

Connecting the Power Logger to the Network

Warning

- **To prevent the risk of electric shock, when connecting current circuits, the corresponding test leads must first be connected to the Logger and then to the load.**
- **Adhere to local and national safety codes. Individual protective equipment must be used to prevent shock injury where hazardous live conductors are exposed.**
- **Use only specified current probes. If flexible current probes are used, wear suitable protective gloves or work on de-energized conductors.**
- **To avoid shock or personal injury, keep fingers behind the tactile barrier, see Figure 5.**

Note

When using either flexi-probes or current clamp sets, make sure the arrow on the current probe points towards the load.

Use the original cables only for connecting the current probes and the voltages to the Logger. If these are damaged do not use them. Before connecting to the load, make sure that all plugs are connected correctly to the Logger and locked, in order to prevent contact with live conductors.

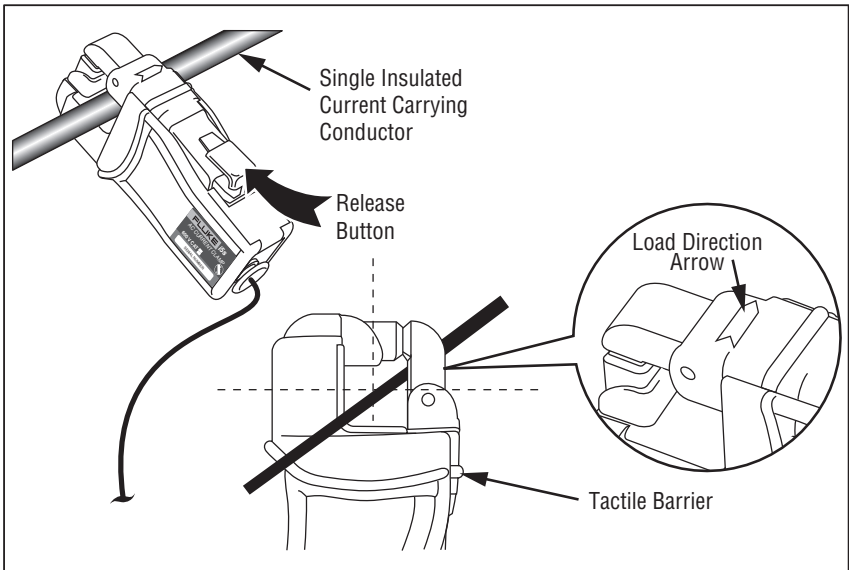

edx045f.eps

Figure 5. Using the Optional Mini Clamps

Color Coding Wire Clips

Your Logger includes a set of color clips that you can attach to the test leads. These help you keep track of which current probe lead and voltage lead belongs to which phase. The large clips are for the current probe leads and the small clips are for the voltage leads. Use the plastic rod tool to help you attach the clips.

Single and Split Phase Connections

For Single Phase + Neutral, refer to Figure 6 and connect the leads as follows:

Voltage:

Network	Test Leads
Line	A (L1)
Line (same)	B (L2)
Line (same)	C (L3)
N	N

Current:

Network	Test Leads
L1	A (L1)
Not connected	B (L2)
Not connected	C (L3)
N	N

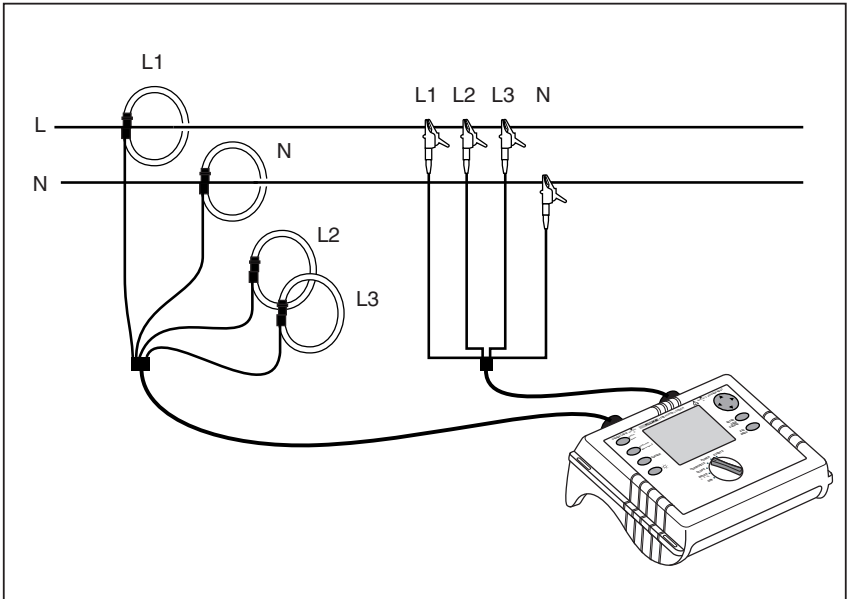

edx040.eps

Figure 6. Single Phase Connections

Split Phase

For Split Phase, the Neutral is center-tapped and there are two hot legs which correspond to A and B test Leads. AB is the voltage from phase to phase, which is twice that of each individual hot leg. Refer to Figure 7 and connect the leads as follows:

Voltage:

Network	Test Leads
Line 1	A (L1)
Line 2	B (L2)
Line 1	C (L3)
N	N

Current:

Network	Test Leads
A (L1)	A (L1)
B (L2) Line 1	B (L2)
Not connected Neutral	C(L3)
N	N

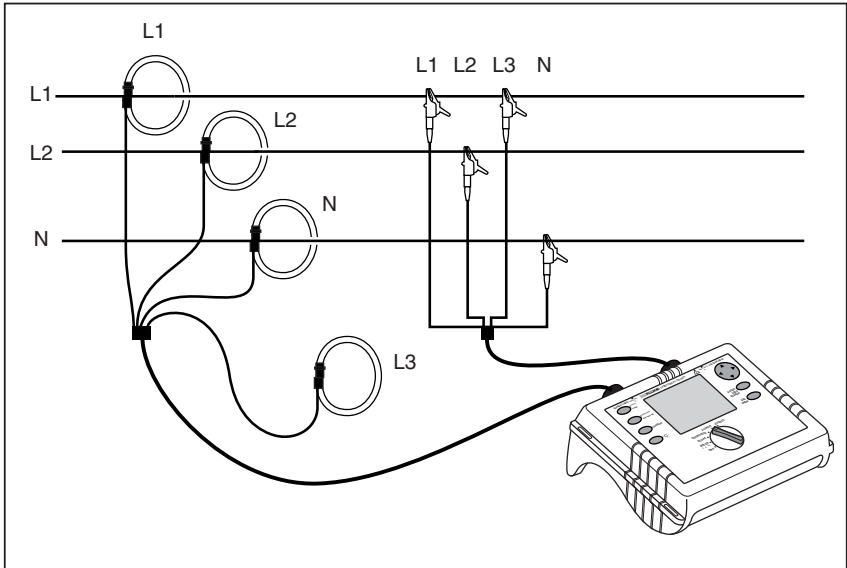

edx041.eps

Figure 7. Split Phase Connections

Measurement in a Three-Phase Power Network

In order to measure all phases in the three-phase power network with the Logger you attach your Logger to the measuring power network according to the following figures.

See 'Power' for further details.

Voltage:

Mains Line	Test Leads
A (L1)	A (L1)
B (L2)	B (L2)
C (L3)	C (L3)
N	N

Current:

Mains Line	Test Leads
A (L1)	A (L1)
B (L2)	B (L2)
C (L3)	C (L3)
N	N

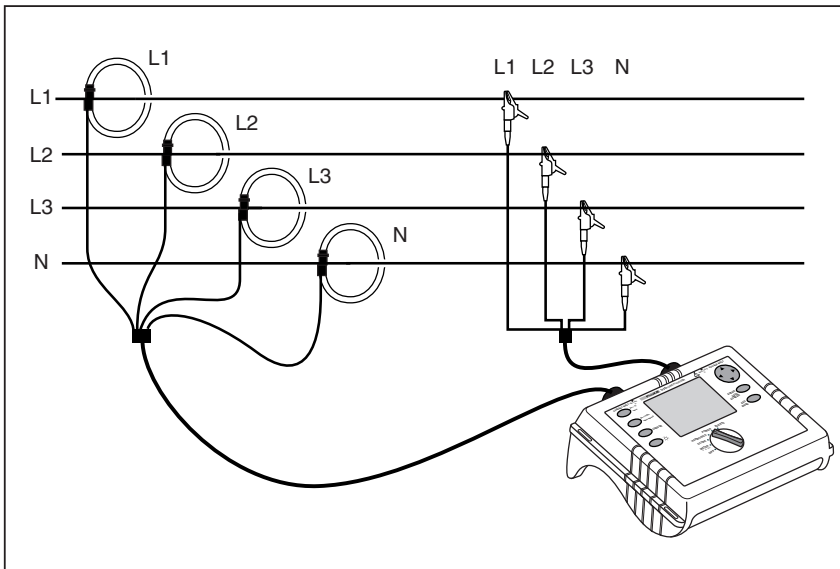
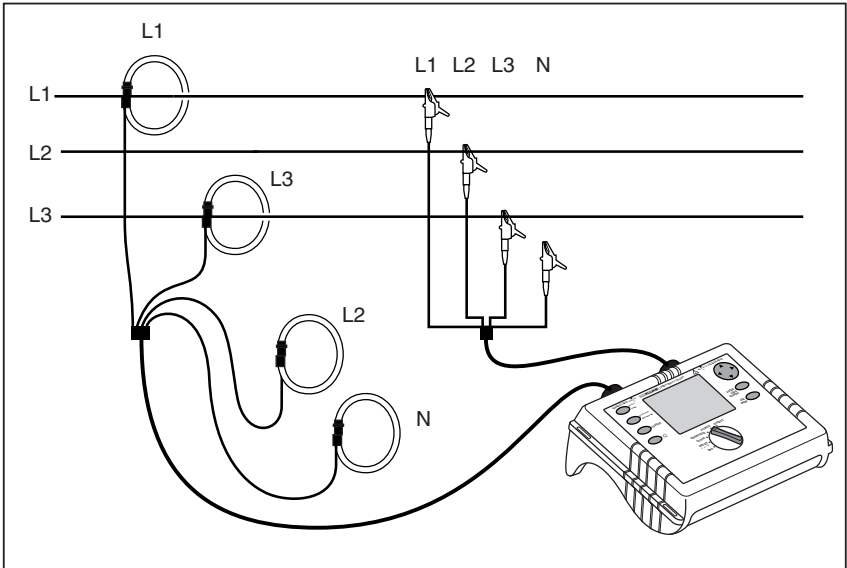

Figure 8. Three-Phase Wye Connections

edx042.eps



edx043.eps

Figure 9. Three-Phase Delta Δ Connections-Blondel (Aron, Two-Element Delta)

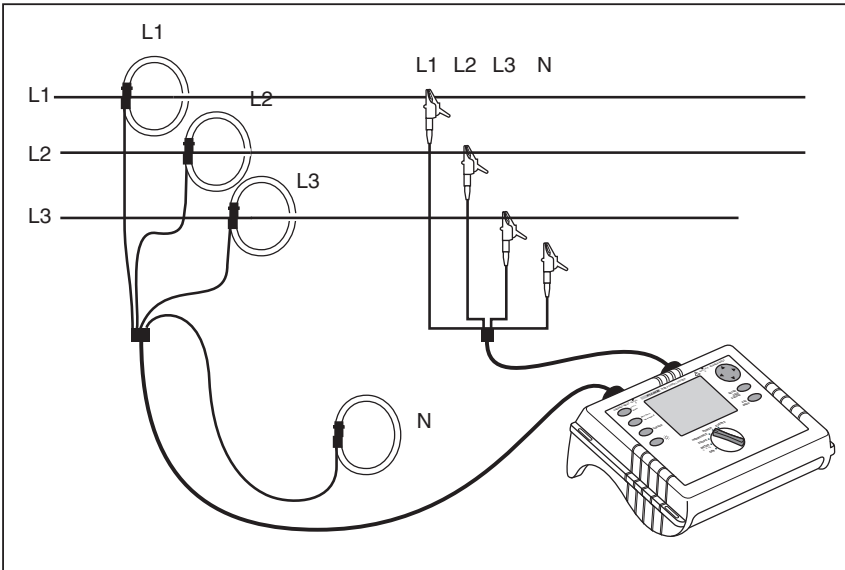

Figure 10. Three-Phase Delta Δ Connections-Blondel (Aron, Three-Element Delta)

edx046f.eps

Volts / Amps / Hertz

Select Meter with the rotary switch.

In this mode you can measure values for each phase (A, B, C) of

- Voltage (V)
- Current (I)
- Frequency (F)
- Neutral-conductor current (In)

You can determine and store the values. It is also possible to log the values with the logging function.

Measurement or calculation of the neutral-conductor current is optional.

Logging

In Logging mode, the following values are recorded for every phase (A, B, C)

- Voltage (V) and
- Current (I) and the value of the
- Frequency (F)

These values can be recorded in the instrument, downloaded and evaluated with the *Fluke Power Log* software package

Measurement

If you select this measuring mode you will see the following display:

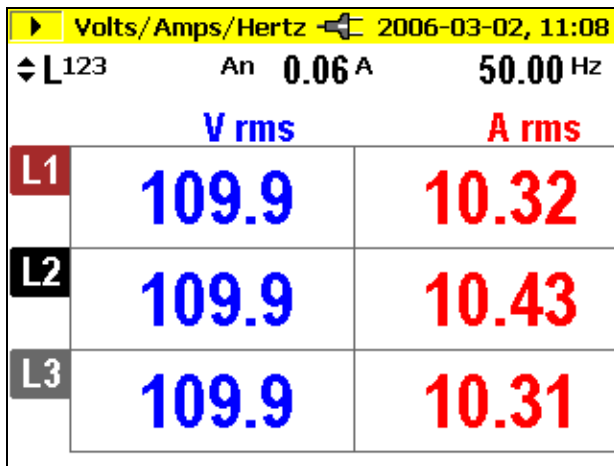

	V rms	A rms
L1	109.9	10.32
L2	109.9	10.43
L3	109.9	10.31

edx024.bmp

- △▽ Use this switch to get the following values:
- minimum of values
 - maximum of values and
- ◁▷ - frequency or neutral-conductor current

With *Hold/Run* the actual values “freeze” and the measurement is stopped or started again.

Save

With *Save/Enter* you will get a screenshot and thus store the actual picture of the display in the memory location subsequently shown.

Logging Function

With *Record/Measure* you can start the logging function or you can get back into the measuring mode. Before the start, the maximum logging time is indicated and you can change this value with *Esc* followed by entering using the *Cursor* key.

Changes in the averaging time, cause corresponding changes in the logging time of the measurement (double averaging time = double logging time).

When the logger graphics reach the screen margin during recording, a picture of this screen is saved.

The display is then deleted and the recording is continued. Up to 6 auto screens are saved in the course of a recording. The saved screenshots can be retrieved via the *View Auto Screenshots* menu.

Note

Do not forget to operate the Logger with the AC adapter during logging in order to prevent shutdown caused by low battery.

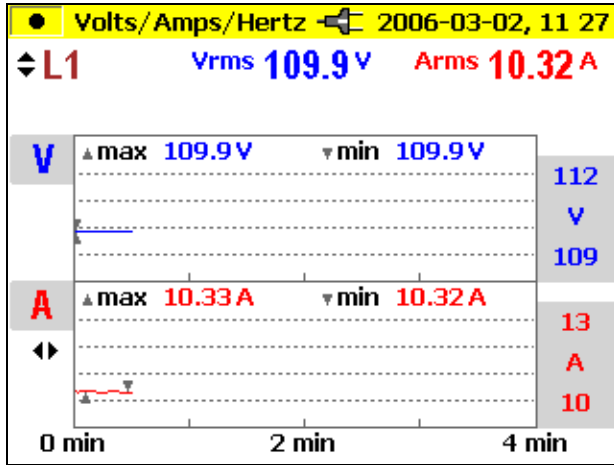

edx025.bmp

- △▽ Select between the individual phases
- ◁▷ Select between the two representation modes:
 - V and I (see fig.)
 - V and F
 - V and In

Analyzing the measured values of the recorder function:

These values can be recorded in the instrument, downloaded and evaluated with *Fluke Power Log* software package.

Power

Select Power with the rotary switch.

In this measuring mode you can get the following values for each phase (A, B, C):

- Power (P) in W (for each phase and its sum P_{tot}).
- Reactive power (Q) in var (for each phase and its sum Q_{tot}).
- Apparent power (S) in VA (for each phase and its sum S_{tot}).
- Distortion power (D) in VA (for each phase and its sum D_{tot}).
- Power factor (PF) and the average PF for the three phases.
- Cos ϕ and the average cos ϕ for each of the three phases.

- Active energy (EP) in kWh.
- Reactive energy (EQ) in kVAR.

Note

When operating in DELTA connected modes, the Logger will only display the Ptotal, Qtotal, and the related Power Factor.

Measurement

You can determine the instantaneous values and store them. You can also record the values with the recorder function.

If you select this measurement mode you will get the following display:

▶ Power		📅 2006-03-02, 13 18	
↕ L ¹²³	8.378 _{tot} kW	12.44 _{tot} kVA	0.672 _{tot} PF
L1	2.780	4.128	0.673
L2	2.826	4.193	0.673
L3	2.772	4.120	0.672

edx026.bmp

△▽ Switch between the individual phases (detailed view: min- max- values and distorted power and Energy values).

◁▷ Switch between the representation modes:

- kW, kVA and PF
- kW, kVA and DPF
- kW, kVA and kVAR

- kW, kVA and kWh
- kW, kVA and kVARh

On pressing $\triangle\nabla$ the accumulated energy function becomes active, this must be acknowledged by pressing *RUN* to activate the accumulation timer.

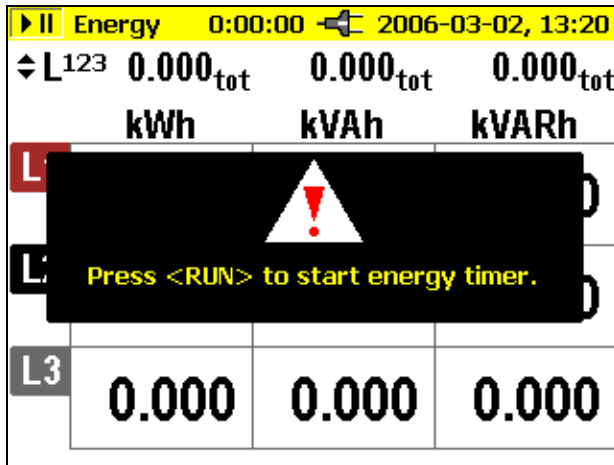

edx027.bmp

The accumulation time is indicated at the top of the measurement display.

A further press of $\triangle\nabla$ gives a detail view of the individual phase values.

Capacitor or inductance symbols issue information about capacitive or inductive reactive power.

With *Hold/Run* the values displayed at the moment “freeze” and the measurement is stopped or started again.

Note

In the individual representation of A or B or C, the active and reactive energy cannot be selected.

Three-Phase Power Theory

By switching the Power Network setting from wye to delta, the voltages and currents I_{L1} , I_{L3} , I_{L2} are calculated, measured and displayed.

When calculating the power, selecting the delta connection will use the two-wattmeter method (Blondel or Aron) measuring circuit for the calculation.

The neutral conductor may be connected, however, it does not influence the measurement even in open state. If no neutral conductor is connected, a virtual "metering neutral" is established in the Logger via symmetrization resistors.

In the Blondel (or Aron) circuit, phase L2 becomes the return line for L1 and L3 causing the current I_{L2} to be obtained as the sum of the two negative currents I_{L1} I_{L3} .

$$i_2(t) = -[i_1(t) + i_3(t)]$$

In general, the instantaneous total power is:

- $P_{tot}(t) = v_1(t) i_1(t) + v_2(t) i_2(t) + v_3(t) i_3(t)$
- $P_{tot}(t) = v_1(t) i_1(t) - v_2 [i_1(t) + i_3(t)] + v_3(t) i_3(t) =$
 $= [v_1(t) - v_2(t)] i_1(t) + [v_3(t) - v_2(t)] i_3(t)$

However, since the voltages between the lines of a poly-phase are measured in the delta connection, the following formula results for the total power:

$$P_{tot}(t) = v_{12}(t) i_1(t) + v_{32}(t) i_3(t)$$

Integration via a period results in:

$$P_{tot} = V_{12} I_1 \cos(V_{12}, I_1) + V_{32} I_3 \cos(V_{32}, I_3)$$

Therefore, the total power corresponds to the total power of the Wye connection. For control purposes, it can be derived from the sum of the powers P_{12} and P_{31} .

Since I_{L2} is only calculated as an auxiliary value and is not measured, P_{23} must be set to zero (as per definition), because it does not exist in the Aron circuit.

The power factor PF has no physical meaning in the Aron circuit, because one would compare the current to the voltage between the lines of a poly-phase system. Reactive and apparent power should be understood as pure computing values and have no physical meaning.

Invalid measurements are suppressed from the display by the symbol '----'.

The exact formulae for calculating the active power are given in the section Measurement Theory.

Save

With *Save/Enter* you will get a screenshot and thus store the actual display in the memory location shown subsequently.

Logging Function

With *Record/Measure* you can start the logging (recorder) function or you can get back into the measuring mode. Before the start, maximum recording time is indicated and you can change this value with cursor.

Changes in the averaging time, cause corresponding changes in the recording time of the measurement (double averaging time = double recording time).

When the recorder graphics reach the screen margin during recording, a picture of this screen is saved.

The display is then deleted and the recording is continued. Up to 6 auto screens are saved in the course of a recording. The saved screenshots can be retrieved via the *View Auto Screenshots* menu.

Note

Do not forget to operate the Logger with the BC 1735 AC Power Adapter during recording in order to prevent shutdown caused by low battery.

Active and reactive energy are not shown in the recorder function.

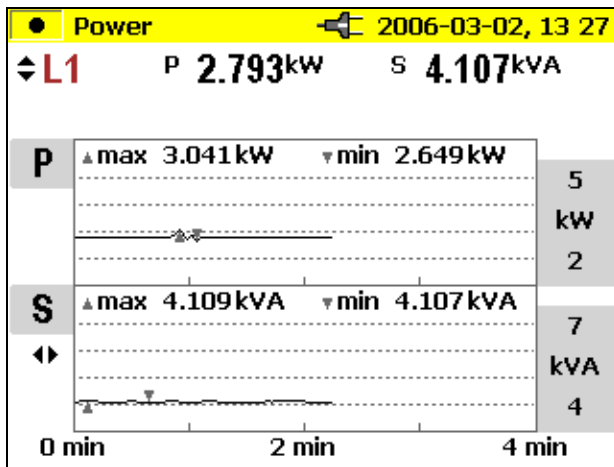

edx028.bmp

△▽ Switch between the individual phases and phase totals

◁▷ Switch between the representation modes:

- kW and PF
- W and D (kVA)
- W and S (kVA)
- W and Q (kVAR)
- W and D

Logging

In the Logging (Record) mode, the following values are recorded for every phase (L1, L2, L3)

- Active power (P)
- Apparent power (S)
- Reactive power (Q)
- Power factor (PF)
- Cos phi ($\cos\phi$)
- Distortion power (D)
- Accumulated values (kWh, kVAh, kVARh)

These values can be recorded in the instrument, downloaded and evaluated with *Fluke Power Log* software package.

Events

Select Events with the rotary switch.

This measuring mode records the voltage of every phase (L₁, L₂, L₃) in cases of voltage dips, swells or interruptions (recorder function).

This function exclusively works with the recorder function.

Before you start the measurement, select the desired threshold value with *Menu/Esc* (under recording adjustments). After the measurement has started the following message appears on the display.

```
. . . waiting for events
```

The Logger is now in the trigger mode. If an event on one of the phases occurs, the recording is started automatically and lasts for 4 minutes. The MIN and

MAX values of the half-cycle RMS values are shown as graphs. The screenshots recorded by this method are saved as individual pictures and can be viewed later, or the data can be displayed with the *Power Log* software. A total of 999 events can be recorded. In the LC display the phase and the number of recordings are displayed.

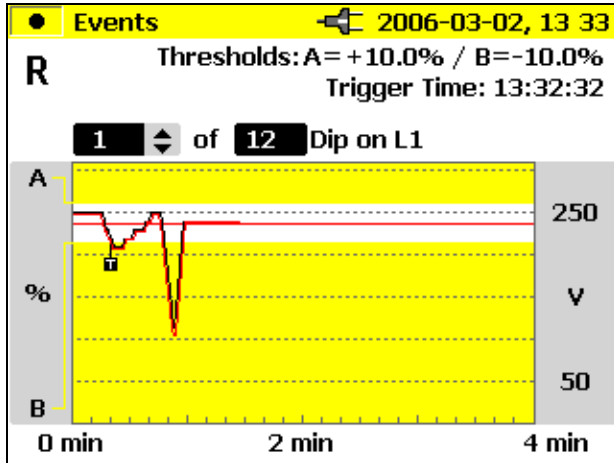

edx029.bmp

△▽ Switch between the individual events (if there is more than one).

This is also possible if the recording has been stopped and you want to evaluate the stored events.

With *Hold/Run* you can stop/start the measurement or you can also start a new measurement.

Save

With *Save/Enter* you will get a screenshot and thus store the actual display in the memory location shown.

Logged Events

You can download logged events using *Fluke Power Log* software package.

The *Fluke Power Log* software presents the event data in a variety of formats:

- graphs similar to those displayed on the instrument

- statistical format with number of events, range of duration and range of voltage
- spreadsheet format with date/time stamp, event type and duration

Harmonics

Select Harmonics with the rotary switch.

In this measuring mode you can determine the Harmonics H1 (fundamental frequency) to H50 for all phases (L1, L2, L3) of:

- Voltage (V)
- Current (I)

Measurement

When selecting this measuring mode with the rotary switch the harmonics are immediately and clearly represented on the LC display as follows:

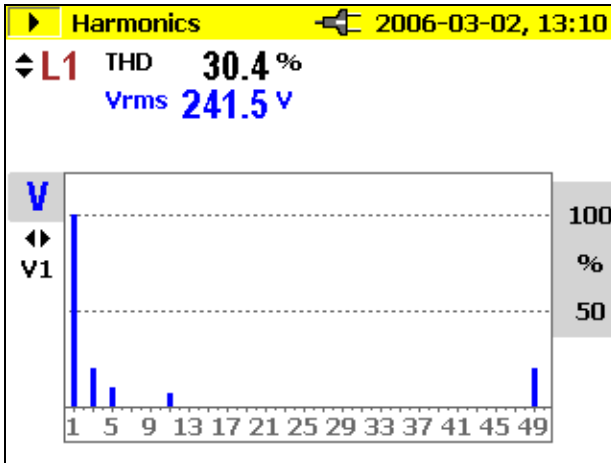

edx030.bmp

△▽ Switch between the individual phases.

◁▷ Switch between V and I.

With *Hold/Run* the values displayed at the moment “freeze” and the measurement is stopped or started again. By pressing the *CURSOR* key, you will go into *Cursor* mode, where you can read additional values of the

individual harmonics. With $\triangle \nabla$ you can change the scale; use $\triangleleft \triangleright$ to select the individual harmonic from 100 %-50 % to 50 %-25 % or 10 %-5 %.

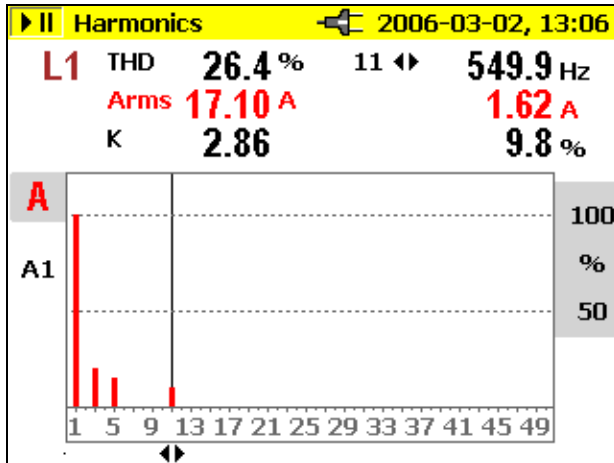

edx031.bmp

Logger Function

Record/Measure starts the logging function or toggles from logging to measurement mode, respectively.

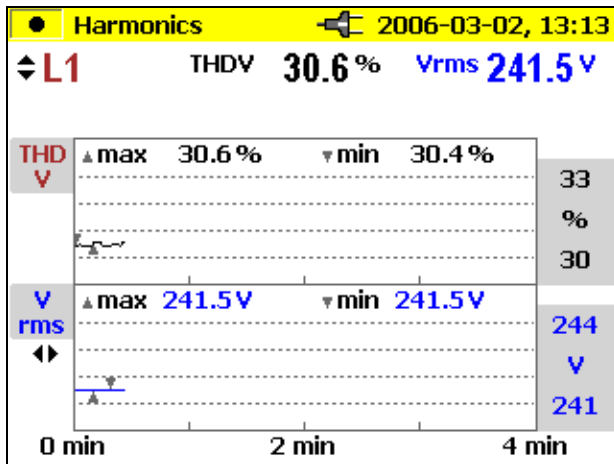

edx032.bmp

$\triangle \nabla$ Switching between individual phases

◀▶ Switching between V and I

When the recorder graphics reach the screen margin during recording, a picture of this screen is saved.

The display is then deleted and the recording is continued. Up to 6 auto screens are saved in the course of a recording. The saved screenshots can be retrieved via the *View Auto Screenshots* menu.

You can exit a measurement with *HOLD*, however, the measurement cannot be continued afterwards. In order to evaluate the measurement values of the recorder function:

Use the *Cursor* key. Using the cursor control keys, select the respective time and read the corresponding measurement value.

Logging

In Logging mode, the following values are recorded for every phase (L1, L2, L3)

- Voltages (V) and
- Currents (I)
- THD V
- THD I
- Values of uneven harmonics from 1-25 for V and I shown as 25 bars, for example fundamental + 24 harmonics, including even harmonics.
- Frequency

These values can be recorded in the instrument, downloaded and evaluated with *Power Log* software package

Save

With *Save/Enter* you will get a screenshot and thus store the actual display in the memory location shown subsequently.

Scope

Select Scope with the rotary switch.

In this measuring mode you get a live picture of the waveforms of

- Voltage (V)
- Current (I)
- Angle (φ)

for all three phases (L1, L2, L3).

Measurement

If you select the measuring mode with the rotary switch the following figure appears on the display. The three phase voltages and current values are plotted for the time of one period.

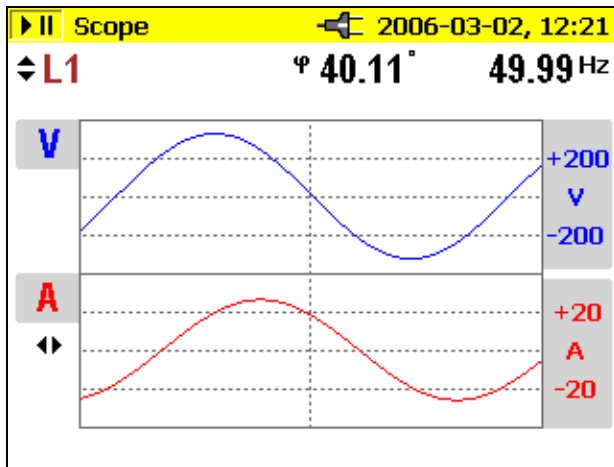

△▽ Switch between the individual phases or total view of all phases.

◁▷ While viewing the individual phases, the cursor can be shifted and the value at this location is displayed.

In the individual view, the φ angle is also shown.

With *Hold/Run* the momentary values “freeze” and the measurement is stopped or started again.

Save

With *Save/Enter* you will get a screenshot and thus store the actual display in the memory location shown subsequently.

Note

In this mode the recorder function is not available. The angle (φ) describes the phase shift between first harmonic active power and first harmonic reactive power. See formula in the Measurement Theory section for more details.

Power Log PC Software

Power Log provides data download, analysis and reporting in one simple to use package.

Installing Power Log Software

Insert the supplied CD-ROM, the main menu starts automatically (if it doesn't double-click on "launch.exe" and execute the program). Please follow the instructions appearing on the screen (menu):

Power Log is a simple but complete application designed to help the user get the most from the 1735 Power Logger.

Check www.Fluke.com for any available new releases.

Starting Power Log

1. Click the Start button.
2. From the start menu, point to programs, point to Fluke Power Log then click *Fluke Power Log*.

For 3 seconds there is a screen that identifies the program:

Then your screen will look similar to this:

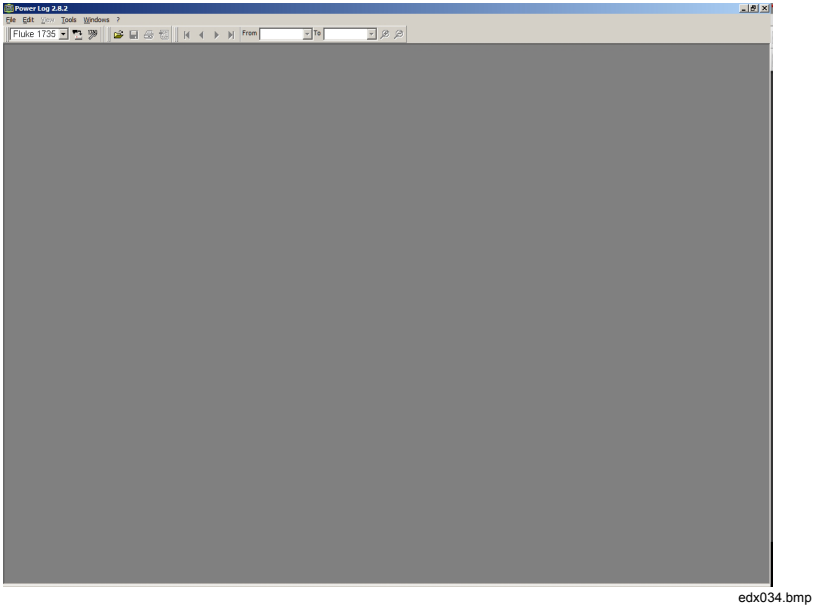

Figure 11. Fluke Power Log Screen

Fluke Power Log incorporates several toolbars which provide quick access to commonly used functions. These functions are also accessible from the Menu Bar. All toolbars can be re-arranged by dragging them, or make them ‘float’ over the application. It is also possible to hide them by clicking the ‘x’ button when ‘floating’.

Using Power Log

Primary functions:

- The Download data button. A connection will be established with the 1735 Power Logger, and all Logger recordings will be downloaded.
- The *Main Toolbar* also comprises of 4 items, but only 1 is active at start-up:

Open data from File: To retrieve previously saved data files from the PC hard drive.

- The other 3 buttons are active when the *Fluke Power Log* has data stored in memory:
 - Save data to File.
 - Print Current Screen.
 - Print report. This produces a printed report of the information on screen. It is possible to adjust the report parameters to avoid the printing of data not required and the generation of large reports.

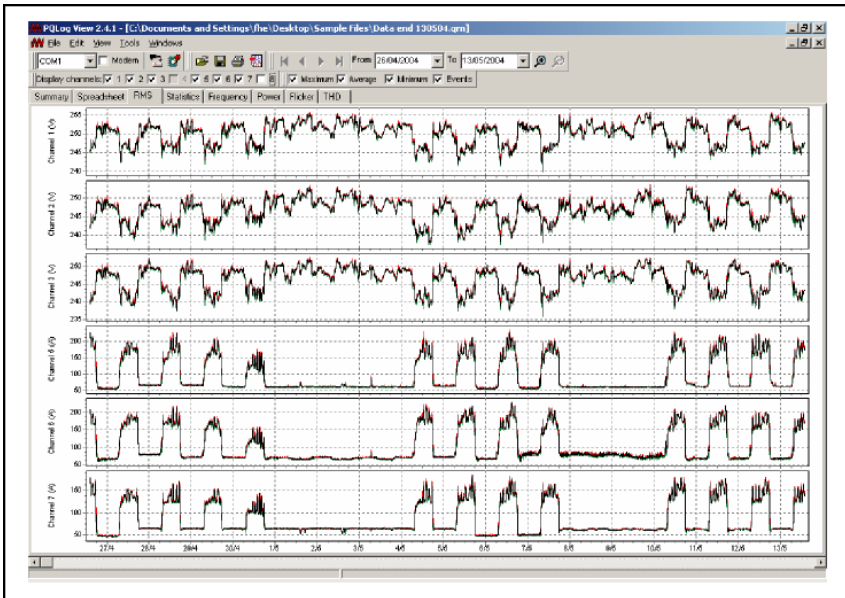

Figure 12. Fluke Power Log Displaying Three Phases of Voltage and Current

edx035.bmp

In the *Power Log*, every file has its own window within the main one. This allows files to be open simultaneously for comparison. Each of these windows has tab markers, which are used to select different viewing modes of the recorded data.

Energy Recording with Fluke Power Log

The supplied software *Fluke Power Log* enables analysis of energy data in two modes.

The first mode shows the energy as an incremental graph:

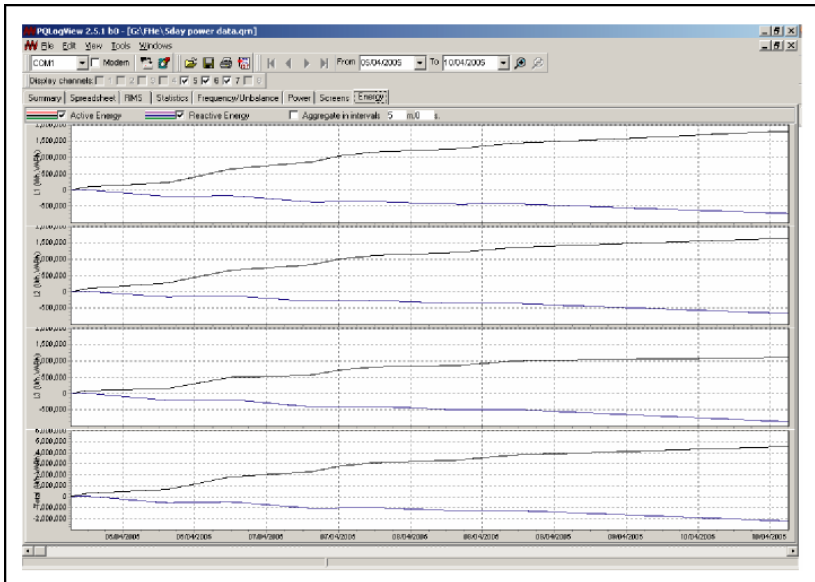

edx036.bmp

The second mode allows a time aggregation period to be set. The minimum aggregation time is the same as the recorded average period. Values greater than the recorded period may also be set.

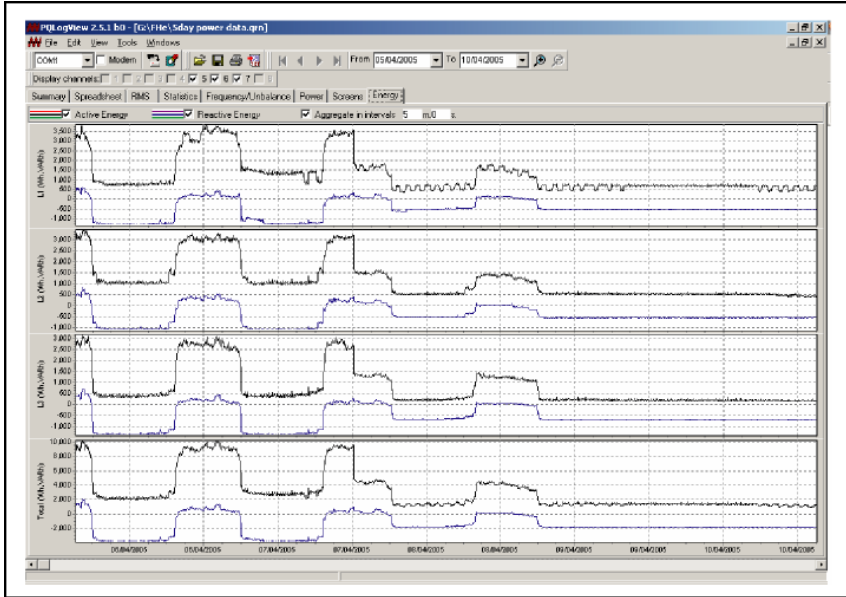

edx037.bmp

Recording Power (Demand) with 1735 Power Logger

This section provides an example of using the logging function to record 15-minute demand averages over 30 days. However, this is only one example of the types of recordings that you can make.

The export of events is an exception, which is described separately in “Using Power Log.”

- Connect Logger to the power network at switchgear, a junction box, or breaker panel, or other convenient access point; set up for POWER.
- Start the measurement by pressing Record.
- In the POWER switch position,, Logger can record up to 4,320 intervals based on the preset interval time. The process can be cancelled by pressing RECORD/MEASURE at any time.

Table 4. Maximum Possible Measuring Periods

Measurement Function	Average Interval	Recording Time
V/A/Hz, Harmonics, Power	½ sec	36 minutes
	1 sec	1 hour, 12 minutes
	2 sec	2 hours, 24 minutes
	5 sec	6 hours
	10 sec	12 hours
	30 sec	1 day, 12 hours
	1 min	3 days
	5 min	15 days
	10 min	30 days
	15 min	45 days
	20 min	60 days

Inside the Logger

Line Power or Battery Mode

You can operate the Logger continuously with the provided charging adapter or for a few hours with the built-in battery. The battery is to ride through power interruptions during logging sessions, and to provide operating power during handheld troubleshooting and analysis of signals.

If you operate your Logger with the ac adapter, the battery is charged automatically. On the display the symbol for “plugged-in” or battery is displayed accordingly.

If the battery is completely discharged, it takes about 4 hours to charge it completely. It is impossible to overcharge the battery as the Logger has an automatic charging circuit.

When LO-BAT is indicated, attach the ac adapter to recharge the battery.

Replacing the Battery Pack

If the battery life is noticeably low (see technical specification), then it has to be replaced. Replace the battery as follows, refer to Figure 13:

1. Turn off the Logger
2. Disconnect all measuring leads
3. Open the battery compartment (two cross-notched screws)
4. Unplug and replace the battery pack. Close the battery compartment again.

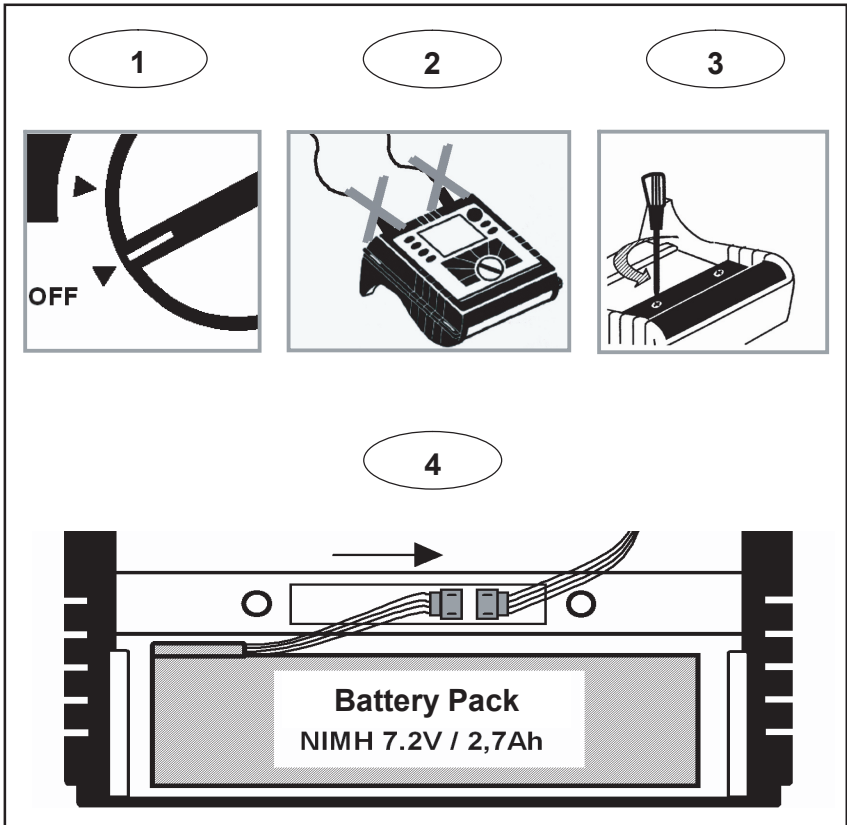

edx038.eps

Figure 13. Replacing the Battery Pack

Note

If you replace the battery please use original spare parts only – see section “Standard and Optional Accessories”.

Maintenance

If the Logger is used appropriately it does not require special maintenance or repair. Maintenance work may be executed only by trained and qualified personnel. This work may only be done at a company related service center within the guarantee period. See www.fluke.com for locations and contact information of Fluke Service Centers worldwide.

Cleaning

⚠Caution

To avoid damaging the Logger, do not use abrasives or solvents on this instrument.

If the Logger gets dirty, wipe it off carefully with a damp cloth (without cleaning agents). Mild soap may be used.

Calibration

As an additional service we offer the regular examination and calibration of your Logger.

Storage

If the Logger is stored for longer time or is not in use for longer time, you should charge the battery at least once every six months.

Measurement Theory

The following formulas are the basics of the measuring values:

Voltage and current measurement

$$V_{RMS} = \sqrt{\frac{1}{T} \int v^2 dt} \quad \text{RMS value of voltages}$$

$$I_{RMS} = \sqrt{\frac{1}{T} \int i^2 dt} \quad \text{RMS value of currents}$$

$$I_N = I_1 + I_2 + I_3 \quad \text{RMS value of neutral-conductor current}$$

Neutral is calculated when not measured, i.e., no 4-phase Flexi set is connected.

Waveform

The angle given in the waveform function is based on the following formula.

$$\varphi = \arctan \left[\frac{P_1}{\sqrt{P_1^2 + Q_1^2}} \right] \quad \text{Angle between}$$

Q_1 reactive power of first harmonic

P_1 active power of first harmonic

Power Measurements

$$P = \sum_{k=1}^{50} V_k \times I_k \times \cos(\varphi_k) \quad \text{active power (200 ms average values)}$$

V_k, I_k, φ_k values of harmonics

$$P_M = \frac{1}{M} \sum_{i=1}^M \vec{P}_i \quad \text{active power over average interval}$$

	Pi to single 200 ms values
	M to number of values
$P_{tot} = P_1 + P_2 + P_3$	total active power
$P_{tot} = P_1 + P_3$	Total Active Power-Blondel (Aron)
$Q_{tot} = \sqrt{S_{tot}^2 - P_{tot}^2}$	Total Reactive Power-Blondel (Aron)
$S_{tot} = \frac{\sqrt{V_{12}^2 + V_{23}^2 + V_{31}^2} \cdot \sqrt{I_1^2 + I_2^2 + I_3^2}}{\sqrt{3}}$	Total Apparent Power
$I_2 = -(I_1 + I_3)$	Blondel (Aron) circuit
$Q = \sum_{k=1}^{50} V_k \times I_k \times \sin(\varphi_k)$	reactive power (200 ms average values)
	Vk, Ik, φk values of harmonics
$Q = \frac{1}{M} \sum_{i=1}^M Q_i$	reactive power over average time
$S = V \times I$	apparent power
$PF = \lambda = \frac{P}{S}$	power factor
$D = \sqrt{S^2 - P^2 - Q^2}$	distortion power
$\cos \varphi = \frac{P_1}{\sqrt{P_1^2 + Q_1^2}}$	cosine cosφ

Note

The distortion power is > zero if the waveform of current is different from the voltage waveform.

Total Harmonic Distortion

$$THD = \frac{\sqrt{\sum_{h=2}^{50} (V_h)^2}}{V_1} \times 100\%$$

Total Harmonic Distortion

V₁ to RMS of the fundamental

V_h to RMS of the h-th harmonic

$$k - factor = \sum_{h=1}^{50} \left(\frac{I_h}{I_{RMS}} \right)^2 \cdot h^2$$

k-factor

I_h ... h-th harmonic (amps)

I_{RMS} ... RMS amps

h ... harmonic order

Specifications

General

Display:	¼ VGA Graphic Color transmissive displays 320 x 240 Pixel with additional background lighting and adjustable contrast, text and graphics in color.
Quality:	Developed, designed and manufactured according to DIN ISO 9001
Memory:	4 MB Flash memory, from this 3.5 MB for measuring data;
Interface:	USB/RS232 USB with Mini USB B socket
Sample rate:	10.24 kHz
Line frequency:	50 Hz or 60 Hz, user-selectable, with automatic synchronization

Temperature Ranges

Working temperature range:	-10 °C to +50 °C
Storage temperature range:	-20 °C to +60 °C
Operating temperature range:	0 °C to +40 °C

Note

*The above terms are defined in European Standards.
To calculate the specification at any point in the
working temperature range, use the temperature
coefficient below.*

Temperature coefficient:	± 0.1 % of the measured value per K.
Intrinsic error:	Refers to reference temperature, max. deviation is guaranteed for 2 years.
Operating error:	Refers to operating temperature range, max. deviation is guaranteed for 2 years.
Climatic class:	C1 (IEC 654-1) -5 °C to +45 °C, 5 % to 95 % RH, no dew
Housing:	Cyclopol shock and scratch proof thermoplast V0-type (non-flammable) with rubber protection holster

EMC

Emission:	IEC 61326-1:2006 class B
Immunity:	IEC 61326-1:2006
Power supply:	NiMH battery-pack, with ac adapter (15 V to 20 V/0.8 A)
Operation time with battery:	Typical >8 h with bright backlight, >10 h with low backlight, and 24 h without backlight
Dimensions:	240 x 180 x 110 mm (6.1 x 4.6 x 2.8 in)
Weight:	1.7 kg (3.75 lb), including battery

Safety

Safety:	EN/IEC 61010-1:2001 (2 nd ed.) 600 V CAT III, double or enforced insulation
Pollution Degree:	2
Protection:	IP65; EN60529 (refers only to the main housing without the battery compartment)

RMS values are measured with a 20 ms resolution.

V-RMS Wye Measurement

Measuring range:	57 / 66 / 110 / 120 / 127 / 220 / 230 / 240 / 260 / 277 / 347 / 380 / 400 / 417 / 480 V AC
Intrinsic error:	$\pm(0.2$ % of measured value. + 5 digits)
Operating error:	$\pm(0.5$ % of m. v. + 10 digit)
Resolution:	0.1 V

V-RMS Delta Measurement

Measuring range:	100 / 115 / 190 / 208 / 220 / 380 / 400 / 415 / 450 / 480 / 600 / 660 / 690 / 720 / 830 V AC
Intrinsic error:	$\pm(0.2 \% \text{ of m. v.} + 5 \text{ digit})$
Operating error:	$\pm(0.5 \% \text{ of m. v.} + 10 \text{ digit})$
Resolution:	0.1 V

A-RMS Measurement

Flexi Sets and current probes with voltage output are supported. All current probes must correspond to 600 V / CAT III

Flexi set I ranges: 15 A / 150 A / 3000 A RMS (non-distorted sine wave)

Resolution: 0.01 A

For ranges 150 A/3000 A

Intrinsic error: $\pm(0.5 \% \text{ of m. v.} + 10 \text{ digit})$

Operating error: $\pm(1 \% \text{ of m. v.} + 10 \text{ digit})$

For range 15 A

Intrinsic error: $\pm(0.5 \% \text{ of m. v.} + 20 \text{ digit})$

Operating error: $\pm(1 \% \text{ of m. v.} + 20 \text{ digit})$

The errors of the current probes are not considered.

By using Flexi-Set:

Flexi Set measuring error: $\pm(2 \% \text{ of m. v.} + 10 \text{ digit})$

Position influence: $\pm(3 \% \text{ of m. v.} + 10 \text{ digit})$

CF (typical): 2.83

Note

Error for current clamps is specified separately.

Power Measurement (P, S, D)

- Measuring range: see V RMS and A RMS measurement
- Power errors are calculated by adding the errors of voltage and current
- Additional error due to power factor PF
- Specified error x (1-IPFI)
- Maximum Range with Voltage range 830 V delta-connection and 3000 A current range is 2.490 MW

Intrinsic error: $\pm(0.7\% \text{ of m.v.} + 15 \text{ digit})$

Resolution: 1 kW

Operating error: $\pm(1.5\% \text{ of m.v.} + 20 \text{ digit})$

Typical range with Voltage range 230 V Wye connection and 150 A Current range is 34.50 KW

Intrinsic error: $\pm(0.7\% \text{ of m.v.} + 15 \text{ digit})$

Resolution: 1 W to 10 W

Operating error: $\pm(1.5\% \text{ of m.v.} + 20 \text{ digit})$

The errors of the current sensors themselves have not been considered.

Energy Measurement (kWh, KVAh, kVARh)

Intrinsic error: $\pm(0.7\% \text{ of m.v.} + F \text{ variation error}^* + 15 \text{ digit})$

Resolution: 1 W to 10 W

Operating error: $\pm(1.5\% \text{ of m.v.} + F \text{ variation error}^* + 20 \text{ digit})$

* Frequency variation error $\pm 2\% \text{ m.v.} + 2^* (\% \text{ maximum frequency deviation})$

PF (Power Factor)

Range: 0.000 to 1.000

Resolution: 0.001

Accuracy: $\pm 1\% \text{ of full scale}$

Frequency Measurement

Measuring range: 46 Hz – 54 Hz and 56 Hz – 64 Hz

Intrinsic error: $\pm(0.2\% \text{ of m. v.} + 5 \text{ digit})$

Operating error: $\pm(0.5\% \text{ of m. v.} + 10 \text{ digit})$

Resolution: 0.01 Hz

Harmonics

Measuring range: 1 to 50th harmonic (<50 % von Vm)

Accuracy:

Vm, Im, THDV, THDI:	According IEC 1000-4-7, class B
Vm, Im, THDV, THDI:	According IEC 1000-4-7, class B
Vm \geq 3 % Vn:	5 % V
Vm < 3 % Vn:	0.15 % Vn
Im \geq 10 % In:	5 % Im
Im < 10 % In:	0.5 % In
THDV:	for THD < 3 % - < 0.15 % at Vn for THD \geq 3 % - < 5 % at Vn
THDI:	for THD < 10 % - < 0.5 % at In for THD \geq 10 % - < 5 % at In

Events

Detection of voltage dips, voltage swells and voltage interruptions with a 10 ms resolution and measuring error of the half period sine wave of RMS.

Intrinsic error:	$\pm(1 \% \text{ of m. v. } + 10 \text{ digit})$
Operating error:	$\pm(2 \% \text{ of m. v. } + 10 \text{ digit})$
Resolution:	0.1 V

Unbalance

RMS errors see V-RMS specification.

Phase angle error.

Intrinsic error: $\pm(0.5 \% \text{ of m. v.} + 5 \text{ digit})$

Operating error: $\pm(1 \% \text{ of m. v.} + 10 \text{ digit})$

Resolution: 0.1°

Note

When using Flexi Set please make sure to position the conductor opposite to the Flexi Set-lock (refer following figure).

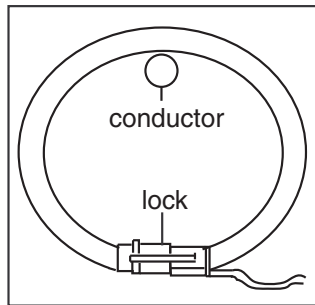

Flexi Set-Lock

edx039.eps]

Appendix A

Values Recorded by the Power Logger

Recorded Values

Measurement function	Saved parameters	Description
Volts/Amps/Hertz		
	Voltages VL1, VL2, VL3, AVG, MIN, MAX RMS values	VoltageV1 AN Volts&Amps VOLTAGE (AVG) VoltageV1 AN Volts&Amps VOLTAGE (MAX) VoltageV1 AN Volts&Amps VOLTAGE (MIN) VoltageV2 BN Volts&Amps VOLTAGE (AVG) VoltageV2 BN Volts&Amps VOLTAGE (MAX) VoltageV2 BN Volts&Amps VOLTAGE (MIN) VoltageV3 CN Volts&Amps VOLTAGE (AVG) VoltageV3 CN Volts&Amps VOLTAGE (MAX) VoltageV3 CN Volts&Amps VOLTAGE (MIN)

	<p>Currents I1, I2, I3, AVG, MIN, MAX RMS values</p>	<p>Current I1 AN Volts & Amps CURRENT (AVG)</p> <p>Current I1 AN Volts & Amps CURRENT (MAX)</p> <p>Current I1 AN Volts & Amps CURRENT (MIN)</p> <p>Current I2 BN Volts & Amps CURRENT (AVG)</p> <p>Current I2 BN Volts & Amps CURRENT (MAX)</p> <p>Current I2 BN Volts & Amps CURRENT (MIN)</p> <p>Current I3 CN Volts & Amps CURRENT (AVG)</p> <p>Current I3 CN Volts & Amps CURRENT (MAX)</p> <p>Current I3 CN Volts & Amps CURRENT (MIN)</p>
	<p>Frequency, AVG, MIN, MAX values</p>	<p>Frequency F TOTAL Volts & Amps VOLTAGE (AVG)</p> <p>Frequency F TOTAL Volts & Amps VOLTAGE (MAX)</p> <p>Frequency F TOTAL Volts & Amps VOLTAGE (MIN)</p>

Harmonics		
	Voltages VL1, VL2, VL3, AVG, MIN, MAX RMS values	VoltageV1 AN Harmonic VOLTAGE (AVG) VoltageV1 AN Harmonic VOLTAGE (MAX) VoltageV1 AN Harmonic VOLTAGE (MIN) VoltageV2 BN Harmonic VOLTAGE (AVG) VoltageV2 BN Harmonic VOLTAGE (MAX) VoltageV2 BN Harmonic VOLTAGE (MIN) VoltageV3 CN Harmonic VOLTAGE (AVG) VoltageV3 CN Harmonic VOLTAGE (MAX) VoltageV3 CN Harmonic VOLTAGE (MIN)
	Currents I1, I2, I3, In AVG, MIN, MAX RMS values	Current I1 AN Harmonic CURRENT (AVG) Current I1 AN Harmonic CURRENT (MAX) Current I1 AN Harmonic CURRENT (MIN) Current I2 BN Harmonic CURRENT (AVG) Current I2 BN Harmonic CURRENT (MAX) Current I2 BN Harmonic CURRENT (MIN) Current I3 CN Harmonic CURRENT (AVG)

		<p>Current I3 CN Harmonic CURRENT (MAX)</p> <p>Current I3 CN Harmonic CURRENT (MIN)</p> <p>Current IN NG Harmonic CURRENT (AVG)</p> <p>Current IN NG Harmonic CURRENT (MAX)</p> <p>Current IN NG Harmonic CURRENT (MIN)</p>
	<p>THD I L1, L2, L3, In, AVG, MIN, MAX RMS values</p>	<p>THD I1 AN Harmonic CURRENT (AVG)</p> <p>THD I1 AN Harmonic CURRENT (MAX)</p> <p>THD I1 AN Harmonic CURRENT (MIN)</p> <p>THD I2 BN Harmonic CURRENT (AVG)</p> <p>THD I2 BN Harmonic CURRENT (MAX)</p> <p>THD I2 BN Harmonic CURRENT (MIN)</p> <p>THD I3 CN Harmonic CURRENT (AVG)</p> <p>THD I3 CN Harmonic CURRENT (MAX)</p> <p>THD I3 CN Harmonic CURRENT (MIN)</p> <p>THD I_n NG Harmonic CURRENT (AVG)</p> <p>THD I_n NG Harmonic CURRENT (MAX)</p> <p>THD I_n NG Harmonic CURRENT (MIN)</p>
	<p>THD V L1, L2, L3, AVG, MIN, MAX RMS values</p>	<p>THD V1 AN Harmonic VOLTAGE (AVG)</p> <p>THD V1 AN Harmonic VOLTAGE (MAX)</p> <p>THD V1 AN Harmonic VOLTAGE (MIN)</p> <p>THD V2 BN Harmonic VOLTAGE (AVG)</p> <p>THD V2 BN Harmonic VOLTAGE (MAX)</p> <p>THD V2 BN Harmonic VOLTAGE (MIN)</p> <p>THD V3 CN Harmonic VOLTAGE (AVG)</p>

		THD V3 CN Harmonic VOLTAGE (MAX) THD V3 CN Harmonic VOLTAGE (MIN)
	Values of odd and uneven harmonics from the 1 st - 25 th order for V1, V2, V3, I1, I2, I3 ,In, AVG, MIN, MAX RMS values	
	Frequency, AVG, MIN, MAX values	Frequency F TOTAL Harmonic VOLTAGE (AVG) Frequency F TOTAL Harmonic VOLTAGE (MAX) Frequency F TOTAL Harmonic VOLTAGE (MIN)
W Power		
		Current I1 AN Power CURRENT (AVG) Current I1 AN Power CURRENT (MAX) Current I1 AN Power CURRENT (MIN) Current I2 BN Power CURRENT (AVG) Current I2 BN Power CURRENT (MAX) Current I2 BN Power CURRENT (MIN) Current I3 CN Power CURRENT (AVG) Current I3 CN Power CURRENT (MAX) Current I3 CN Power CURRENT (MIN) Current I _n NG Power CURRENT (AVG) Current I _n NG Power CURRENT (MAX)

		Current I _n NG Power CURRENT (MIN)
	Real powers P1, P2, P3, AVG, MIN, MAX values	<p>Real Power P1 AN Power POWER (AVG)</p> <p>Real Power P1 AN Power POWER (MAX)</p> <p>Real Power P1 AN Power POWER (MIN)</p> <p>Real Power P2 BN Power POWER (AVG)</p> <p>Real Power P2 BN Power POWER (MAX)</p> <p>Real Power P2 BN Power POWER (MIN)</p> <p>Real Power P3 CN Power POWER (AVG)</p> <p>Real Power P3 CN Power POWER (MAX)</p> <p>Real Power P3 CN Power POWER (MIN)</p>
	Voltages VL1, VL2, VL3, AVG, MIN, MAX RMS values	<p>VoltageVU1 AN Power VOLTAGE (AVG)</p> <p>VoltageV1 AN Power VOLTAGE (MAX)</p> <p>VoltageV1 AN Power VOLTAGE (MIN)</p> <p>VoltageV2 BN Power VOLTAGE (AVG)</p> <p>VoltageV2 BN Power VOLTAGE (MAX)</p> <p>VoltageV2 BN Power VOLTAGE (MIN)</p> <p>VoltageV3 CN Power VOLTAGE (AVG)</p> <p>VoltageV3 CN Power VOLTAGE (MAX)</p> <p>VoltageV3 CN Power VOLTAGE (MIN)</p>

	<p>Apparent powers S1, S2, S3, AVG, MIN, MAX values</p>	<p>Apparent Power S1 AN Power POWER (AVG) Apparent Power S1 AN Power POWER (MAX) Apparent Power S1 AN Power POWER (MIN) Apparent Power S2 BN Power POWER (AVG) Apparent Power S2 BN Power POWER (MAX) Apparent Power S2 BN Power POWER (MIN) Apparent Power S3 CN Power POWER (AVG) Apparent Power S3 CN Power POWER (MAX) Apparent Power S3 CN Power POWER (MIN)</p>
	<p>Reactive powers Q1, Q2, Q3, AVG, MIN, MAX values</p>	<p>Reactive Power Q1 AN Power POWER (AVG) Reactive Power Q1 AN Power POWER (MAX) Reactive Power Q1 AN Power POWER (MIN) Reactive Power Q2 BN Power POWER (AVG) Reactive Power Q2 BN Power POWER (MAX) Reactive Power Q2 BN Power POWER (MIN) Reactive Power Q3 CN Power POWER (AVG) Reactive Power Q3 CN Power POWER (MAX)</p>

		Reactive Power Q3 CN Power POWER (MIN)
	Distortion powers D1, D2, D3, AVG, MIN, MAX values	Distortion Power D1 AN Power POWER (AVG) Distortion Power D1 AN Power POWER (MAX) Distortion Power D1 AN Power POWER (MIN) Distortion Power D2 BN Power POWER (AVG) Distortion Power D2 BN Power POWER (MAX) Distortion Power D2 BN Power POWER (MIN) Distortion Power D3 CN Power POWER (AVG) Distortion Power D3 CN Power POWER (MAX) Distortion Power D3 CN Power POWER (MIN)
	Frequency, AVG, MIN, MAX values	Frequency F TOTAL Power VOLTAGE (AVG) Frequency F TOTAL Power VOLTAGE (MAX) Frequency F TOTAL Power VOLTAGE (MIN)
	Cosφ L1,L2, L3	Cos PHI 1 AN Power POWER (AVG) Cos PHI 1 AN Power POWER (MAX) Cos PHI 1 AN Power POWER (MIN) Cos PHI 2 BN Power POWER (AVG) Cos PHI 2 BN Power POWER (MAX)

		<p>Cos PHI 2 BN Power POWER (MIN)</p> <p>Cos PHI 3 CN Power POWER (AVG)</p> <p>Cos PHI 3 CN Power POWER (MAX)</p> <p>Cos PHI 3 CN Power POWER (MIN)</p>
	<p>Power factors PF1, PF2, PF3, AVG, MIN, MAX values</p>	<p>Power Factor PF1 AN Power POWER (AVG)</p> <p>Power Factor PF1 AN Power POWER (MAX)</p> <p>Power Factor PF1 AN Power POWER (MIN)</p> <p>Power Factor PF2 BN Power POWER (AVG)</p> <p>Power Factor PF2 BN Power POWER (MAX)</p> <p>Power Factor PF2 BN Power POWER (MIN)</p> <p>Power Factor PF3 CN Power POWER (AVG)</p> <p>Power Factor PF3 CN Power POWER (MAX)</p> <p>Power Factor PF3 CN Power POWER (MIN)</p>
	<p>Reactive energy EQ1, EQ2, EQ3</p> <p>Averages only</p>	<p>Reactive Energy EQ1 AN Power ENERGY (AVG)</p> <p>Reactive Energy EQ2 BN Power ENERGY (AVG)</p> <p>Reactive Energy EQ3 CN Power ENERGY (AVG)</p>

	Real energy EP1, EP2, EP3 Averages only	Real Energy EP1 AN Power ENERGY (AVG) Real Energy EP2 BN Power ENERGY (AVG) Real Energy EP3 CN Power ENERGY (AVG)
Events		
	Voltages VL1, VL2, VL3, MIN, MAX of 10-ms RMS values	DIP-Phase CN VALUELOG VOLTAGE MIN VOLTS RMS DIP-Phase CN VALUELOG VOLTAGE MAX VOLTS RMS BAND-Phase CN VALUELOG VOLTAGE MIN VOLTS RMS BAND-Phase CN VALUELOG VOLTAGE MAX VOLTS RMS INTER-Phase AN VALUELOG VOLTAGE MIN VOLTS RMS INTER-Phase AN VALUELOG VOLTAGE MAX VOLTS RMS SWELL-Phase BN VALUELOG VOLTAGE MIN VOLTS RMS SWELL-Phase BN VALUELOG VOLTAGE MAX VOLTS RMS
	Number of events per phase	

This table is valid for WYE mode only. In 2/3 elements delta modes, the data set is reduced.